



catalog of products

2023



**GERMETEX®**  
sealing materials

**12**

years  
in the Market;

**300**

types  
of Products;

**1500**

tons  
per year;

- ISO 9001: 2015 QSCert  
International Quality  
Management  
Certificate;
- Products recognized  
as innovative at  
Innovation Agency  
Session of  
Manufacturers  
in Moscow;
- World Build Awards  
Winner;
- Made in Russia  
Certified  
by Russian Export  
Center

## ABOUT COMPANY



### GERMETEX® sealing materials —

Including self-adhesive, elastomeric, and composite materials — to resolve problems of sealing and hydro-steam insulation in civil and industrial construction, automotive industry and household appliances production.

FULL CYCLE PRODUCTION:  
SYZRAN CITY, SAMARA REGION

RAW MATERIALS (90% RUSSIAN):



MEMBERS OF ASSOCIATIONS:



Association of Adhesives  
and Sealants Manufacturers



NRU.  
National Roofing Union

# CONTENTS

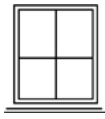

**GERMETEX®**  
Windows & facades.....4-6



**GERMETEX®**  
Greenhouses.....7



**GERMETEX®**  
Roof.....8-11



**GERMETEX®**  
PRO 900.....12-13



**GERMETEX®**  
Roadways.....14-15



**GERMETEX®**  
Acoustics.....16-17



**GERMETEX®**  
Auto.....18-21



**GERMETEX®**  
Waterproofing.....22-23

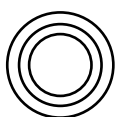

**GERMETEX®**  
Rubber compound.....23



**GERMETEX®**  
Clutch(coupling).....24

**GERMETEX®**  
sealing materials



OUR COMPETENCIES:

## R&D

Research & Development of new products, optimizing of functional and technological parameters

## MANUFACTURER

Design and construction of optimal products for market in terms of «price-quality» ratio

## ENTREPRENEUR

Our channels for cooperation: direct sales, distribution, dealers, joint projects, and private labels (Private Trademark)



**GERMETEX®**  
sealing materials

# WINDOWS & FACADES

**Germetex®** range of mounting tapes will allow you to optimally design and implement junctions and connections of window blocks in conformity with GOST 30971-2012

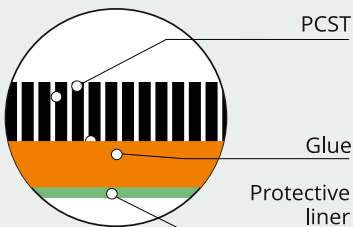
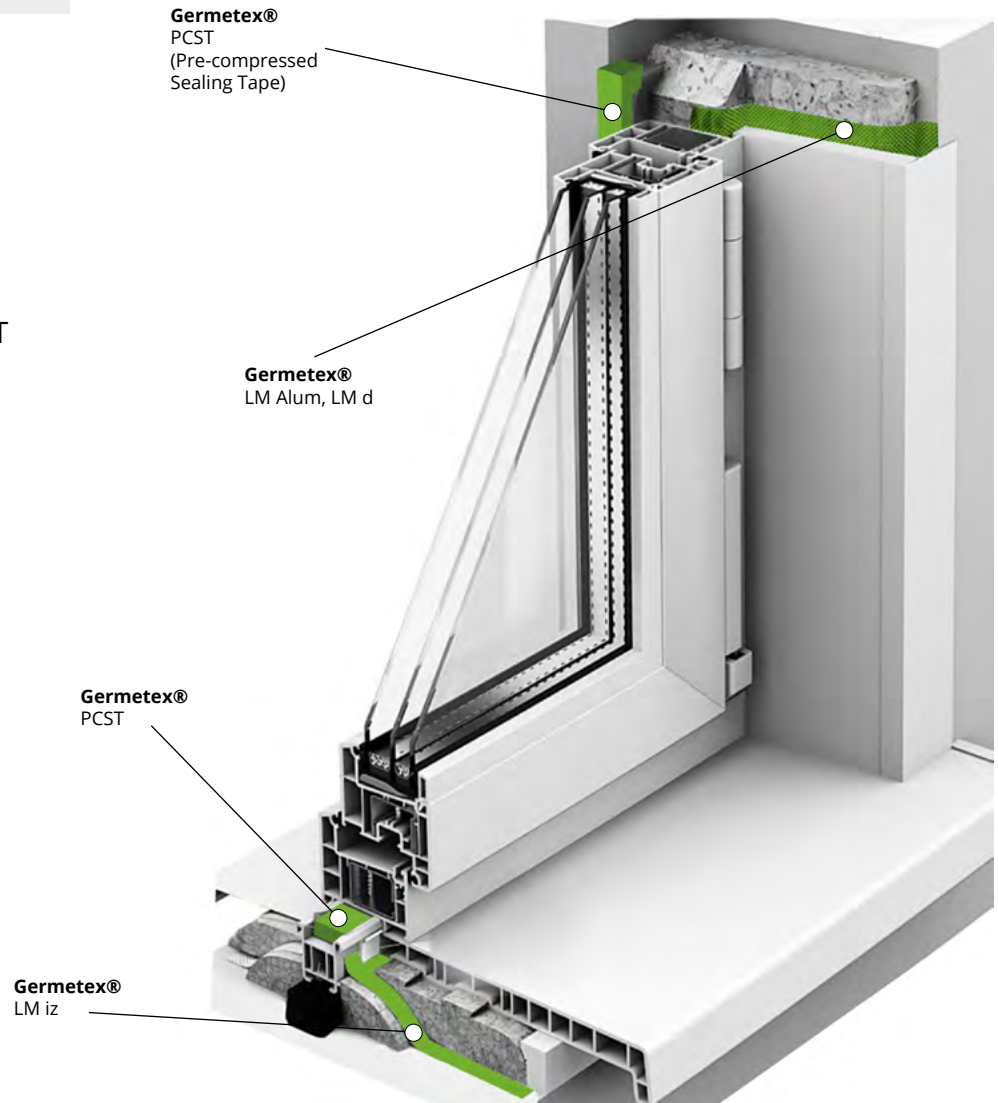

To seal joints and junctions. Protects assembly seam from weathering and ensures vapor diffusion from outside of window block

## WATER INSULATION

### Germetex® PCST 20, 30, 50



Pre-compressed sealing tape, self-adhesive, elastic, based on polyurethane foam with various densities, and impregnated with dispersive acrylic, UV and moisture resistant.

#### SPECIFICATIONS:

Width: 8 to 900 mm.

Thickness: 20 to 40 mm (expanded).

#### PACKAGING: (Typical Dimensions)

Width/Thickness mm	Length per Roll (linear meter, lm)	Quantity per Box (rolls)	Palletized Boxes
15/20	6	20	80
15/30	6	17	80
15/40	4.5	17	80

# WINDOWS & FACADES

GERMETEX®  
sealing materials



## WATER INSULATION

### Germetex® LM Dif



Diffusion (vapor permeable) tape made of durable polypropylene fabric with two fastening strips on edges of butyl rubber sealant on different sides. Installed from outside as drip strip.

**SPECIFICATIONS:**

Width: up to 250 mm. Sealant thickness: 0.6 mm to 5 mm.

**PACKAGING:** (Typical Dimensions)

Width of Tape mm	Length per Roll (linear meter, lm)	Quantity per Box (linear meter, lm)	Palletized Boxes
70	18	54	60
100	18	36	60
120	18	36	60
150	18	36	60

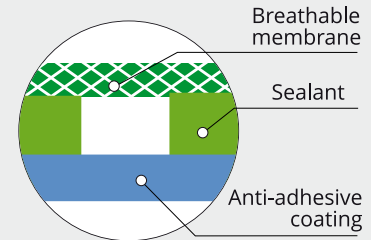

Installed as window drip strip and along opening perimeter, from outside of window block, in absence of window frames.

## VAPOR INSULATION

### Germetex® LM iz



Self-adhesive butyl rubber, moisture-proof, gas-tight tape and heat insulator that backed-up on one side with foamed polyethylene (FPE) as physically cross-linked. Heat insulator.

**SPECIFICATIONS:**

Thermal conductivity coefficient: 0.032 W/m.k. Tape width: from 10 to 900 mm. PPE thickness: from 2 mm to 10 mm. Sealant thickness: 0.4 to 5 mm.

**PACKAGING:** (Typical Dimensions)

PPE Width/Thickness/ Sealant Thickness (mm)	Length per Roll (linear meter, lm)	Quantity per Box (linear meter, lm)	Palletized Boxes
100x3x1.5	9	18	60
200x3x1.5	9	9	60

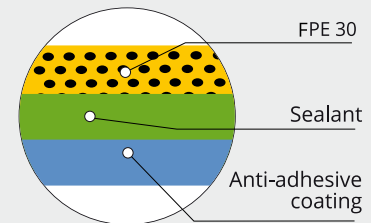

Vapor barrier of assembly joints on inner side of translucent structures.

### Germetex® LM Alum, LM d



**LM Alum** — self-adhesive vapor barrier tape made of metallized aluminum material, with two mounting-sealing strips made of butyl sealant

**LM d** — butyl rubber tape backed-up with non-woven fabric on both sides

**SPECIFICATIONS:**

Width: up to 250 mm (500 mm). Sealant thickness: 0.6mm to 5mm

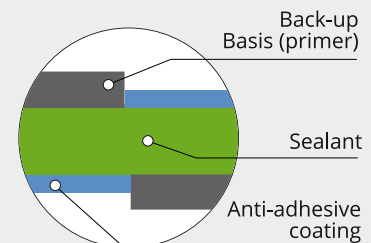

To vapor-tight seal interface between window frames and door frames with building structures, before filling joints with thermal insulation.

**PACKAGING:** (Typical Dimensions)

Width of Tape mm	Length per Roll, (linear meter, lm)		Quantity per Box, (linear meter, lm)		Palletized Boxes
	LM Alum	LM d	LM Alum	LM d	
70	24	18	96	36	60
100	24	18	72	36	60
120	24	18	48	36	60
150	24	18	48	36	60



**GERMETEX®**  
sealing materials

# WINDOWS & FACADES

## APPLICATION:

1. When installing translucent structures under clamping bars (facades, skylights, and winter gardens).
2. At connections of standing and transom systems, to seal expansion gaps.
3. Under window sills, as well as to seal interfaces between elements of translucent structures, seams inside rooms, and light metal structures (LMS).



Germetex®  
LM I, LM I Next

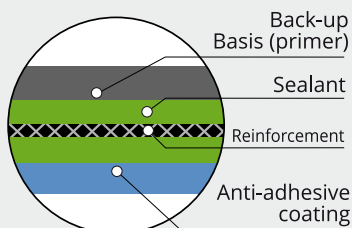
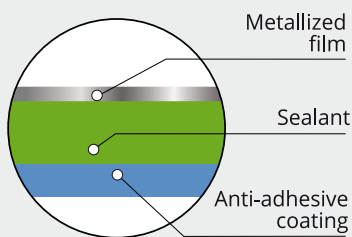

## Germetex® LM I, LM I Next

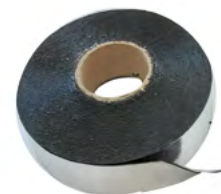

**Germetex LM I** — 3-layer self-adhesive vapor barrier, heat-reflecting butyl rubber tape, backed up on one side with a metallized film.

**Germetex LM I NEXT** — 5-layer butyl rubber tape. Lighter (less heavy) by 30%. More convenient for work at height.

### SPECIFICATIONS:

Width: from 3 mm to 900 mm. Thickness: from 0.6 mm to 3 mm.

### PACKAGING: (Typical Dimensions)

Tape width/Thickness mm	Length per Roll (linear meter, lm)	Quantity per Box (linear meter, lm)	Palletized Boxes
45x1	24	72	60
45x0.6	40	200	60

# GREENHOUSES

**GERMETEX®**  
sealing materials

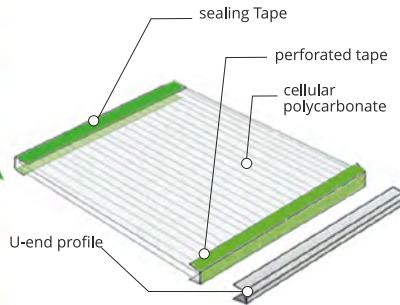

- good elasticity;
- special antifungal treatment;
- protection against penetration of insects and dust;
- simple to install;
- high wear resistance;
- water and heat resistant; and
- continuous process of condensate elimination.

## Germetex® LMp Perforated Tape



Perforated tape coated with special adhesive to provide high level of initial adhesion and good cohesive shear characteristics. The basis of a tape (breathable) membrane provides ventilation of cellular channels.

### SPECIFICATIONS:

Width: 25 mm for sheets 4, 6, 8 mm. sheets 10-16 mm – 38 mm.

### PACKAGING: (Typical Dimensions)

Tape width mm	Length per Roll (linear meter, lm)	Quantity per Box (linear meter, lm)	Palletized Boxes
25	33	1056	30
38	25	500	60

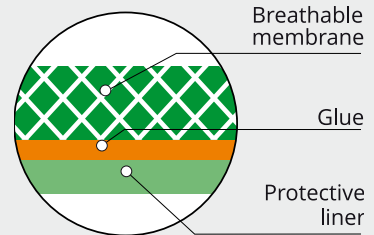

Used for installation of cellular polycarbonate structures. Provides ventilation of cellular channels in sheets, protects against dust, dirt and does not hinder removal of occurring condensate.

## Germetex® LMs Sealing Tape



Base of tape is back-up insulation material, where durable adhesive layer is applied onto. Temperature fluctuations do not affect tape performance. Tape has high-moisture-resistant, can take non-standard contour forms.

### SPECIFICATIONS:

Width: 25 mm for sheets 4, 6, 8 mm. sheets 10-16 mm — 38 mm.

### PACKAGING: (Typical Dimensions)

Tape width mm	Length per Roll (linear meter, lm)	Quantity per Box (linear meter, lm)	Palletized Boxes
25	33	528	72
38	33	759	60

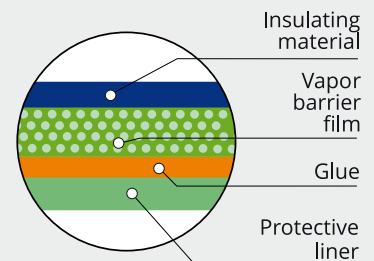

To seal interfaces of polycarbonate sheets with another outdoors and indoors, as well as to seal (sealing) edges of cellular polycarbonate sheets from moisture and dust to ensure transparency of the sheet material.

## Germetex® LM cork 25 Cork Tape



Cork tape is material, based on cork sheet, where adhesive layer applied to glue layer protected by anti-adhesive paper.

### SPECIFICATIONS:

Width: from 5 to 1,000 mm. Density (kg/m³) — 200-250. Thermal conductivity (W/m.K.) — 0.043. Breaking load (kg/cm²) — 2.0. Water absorption (% no more) — 7.0

### PACKAGING: (Typical Dimensions)

Tape Width mm	Length per Roll (linear meter, lm)	Quantity per Box (linear meter, lm)	Palletized Boxes
25	10	300	24
38	10	180	24

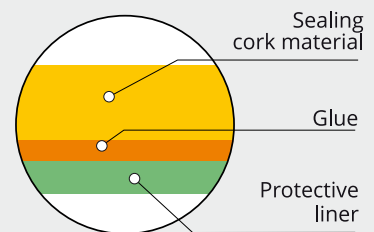

Because of UV radiation resistant as well as providing for expansion joint between metal structures and cellular polycarbonate, products directly installed during installing structures made of cellular polycarbonate, by applying to a metal profiles (frames).

# ROOF

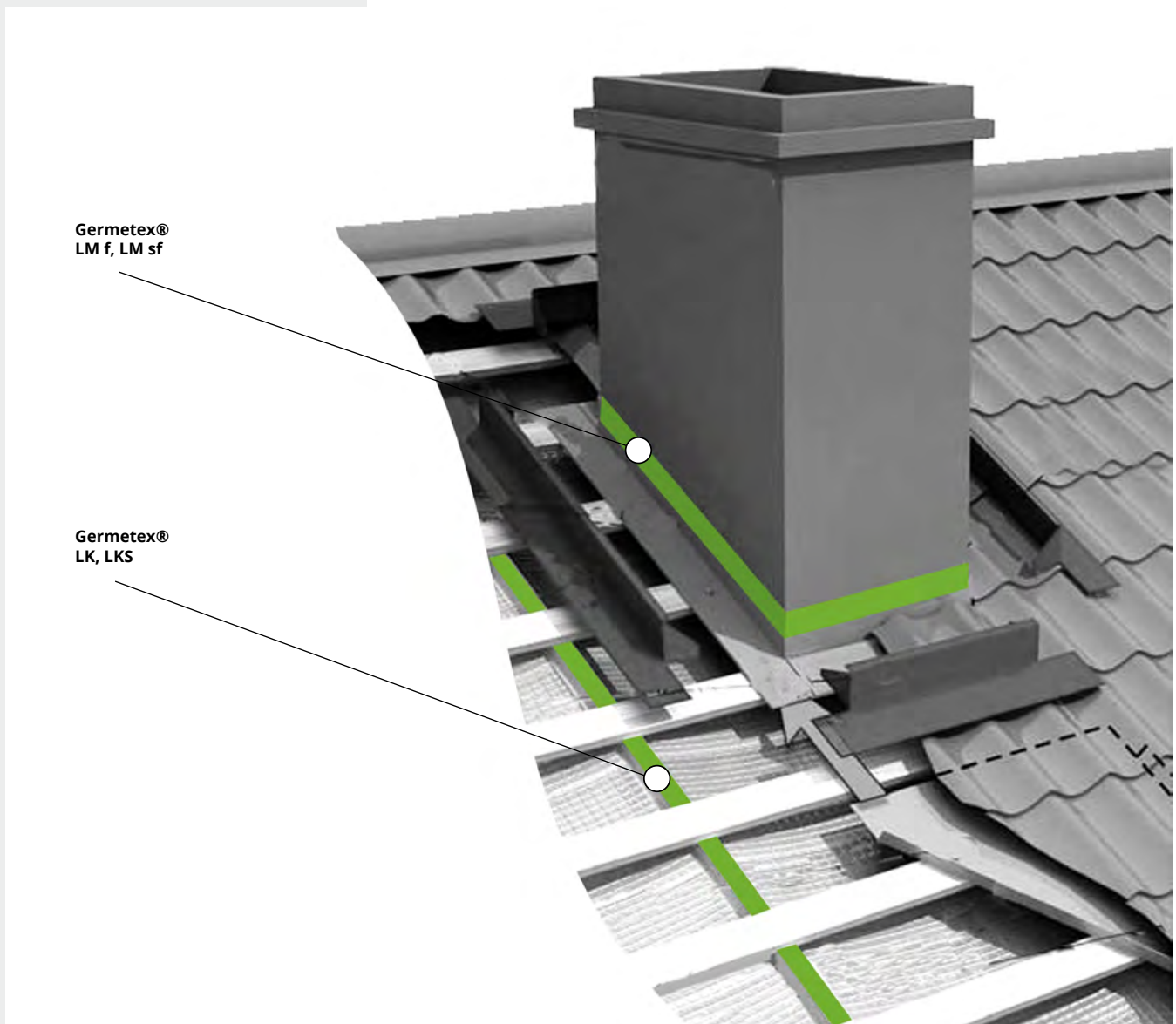

**Germetex®** Roof Sealing materials and sealants to install modern roofing materials:

- roll and mastic;
- asbestos-cement;
- polycarbonate and polymer-cardboard;
- steel sheet;
- ready-made roofing sandwich panels;
- metal corrugated board; and
- roof tiles

# ROOF

GERMETEX®  
sealing materials



## Germetex® LM f, LM sf

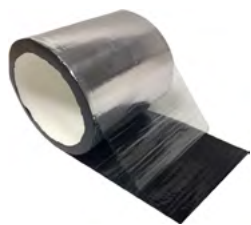

Self-adhesive vapor barrier, heat-reflecting butyl rubber tape, backed-up on one side with aluminum foil reinforced with glass mesh and protective liner on other side

### SPECIFICATIONS:

Min. installation temperature: -15 °C. Operating temperature: from -60 °C to +100 °C.  
Service life: at least 10 years. Width of tapes: from 10 to 900 mm.  
Sealant thickness: from 0.6 mm to 3 mm.

### PACKAGING: (Typical Dimensions)

Tape Width mm	Length per Roll (linear meter, lm)	Quantity per Box (linear meter, lm)	Palletized Boxes
100	10	30	72
150	10	20	72
200	10	40	36

## Germetex® LM np



Universal sealing self-adhesive butyl rubber tape used in places protected from ultraviolet radiation.

### SPECIFICATIONS:

Tape width: from 10 mm to 200 mm; type of Next: from 10 mm to 900 mm.  
Thickness: 0.6 mm to 5 mm; type of Next: 0.6. Winding: on cores into rolls.

### PACKAGING: (Typical Dimensions)

Tape Width mm	Length per Roll (linear meter, lm)	Quantity per Box (linear meter, lm)	Palletized Boxes
100	18	36	60
120	18	36	60
150	18	36	60

## Germetex® LM iz



Sealing, noise-absorbing, and anti-condensation self-adhesive butyl rubber tape, backed up with foamed polyethylene (physically cross-linked).

### SPECIFICATIONS:

Minimum installation temperature, °C: -15.  
Operating temperature: from -60 °C to +90 °C.  
Width of tape: from 10 to 900 mm. FPE thickness: from 2 to 10 mm.  
Sealant thickness: from 0.6 mm to 3 mm.  
Length of tapes, m: depending on thickness of insulation.

### PACKAGING: (Typical Dimensions)

Tape Width/FPE Thickness Sealant Width, mm	Length per Roll m	Quantity per Box pcs	Palletized pcs
30x2x1.5	12	60	60
50x3x1	9	36	60

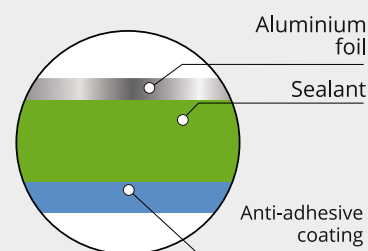

To seal all types of roofing material junctions to surfaces chimneys, roof windows, ridge joints, walls and parapets.

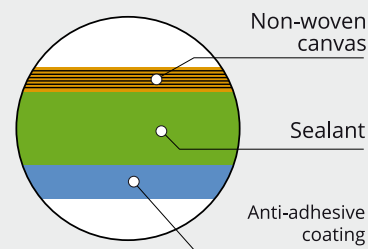

To protect and seal expansion joints. Plastering and coloring of a tape is possible.

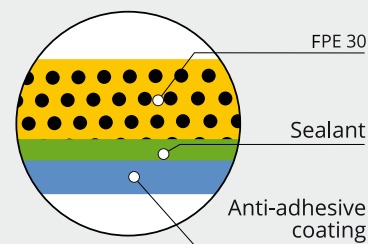

For reliable protection of joints and connections for various purposes, thermal break, and damper.



**GERMETEX®**  
sealing materials

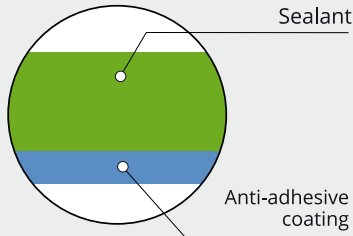

**Germetex® LK**

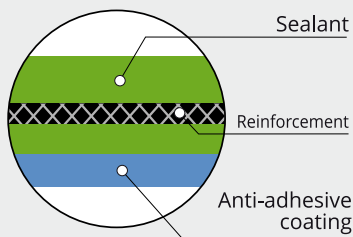

**Germetex® LK s**

To seal, waterproof, and gluing of two surfaces and under-roofing films of vapor barrier and membrane types as well as sealing of roofing sheets at low roof slopes.

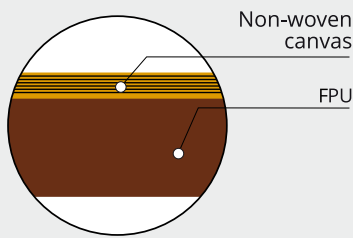

**FPU NW**

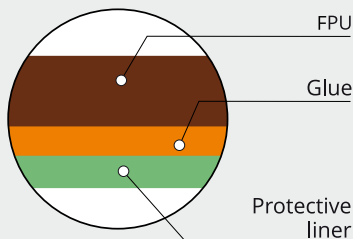

**FPU**

To seal gaps in roofing and wall sandwich panels, in corrugated board and metal tiles.

# ROOF

## Germetex® LK, LK s



Double-sided sealing self-adhesive butyl rubber tape. LK s Brand has additional reinforcing base (made of fiberglass mesh), which increases strength characteristics. Depending on material of additional reinforcement, Germetex® LK tape is subdivided into: LK s, LK p, LK c, and LK f (fiberglass mesh, paper, cloth, and film).

### SPECIFICATIONS:

Adhesion — to steel, N/cm= 10, to concrete, N/cm=10.  
Resistance to flow, mm, at T = 100 °C, 24 hours, no more: 2.0 mm.  
Tape width, mm: 10-200 (4-900 — for LK f tapes).  
Thickness, mm: 1-5 (0.6-1 — for LK f tapes).

### PACKAGING: (Typical Dimensions)

Tape Width mm	Length per Roll (linear meter, lm)	Quantity per Box (linear meter, lm)	Palletized Boxes
10	25	250	60
20	25	225	60
30	15	105	60

Tape Width mm	Length per Roll (linear meter, lm)	Quantity per Box (linear meter, lm)	Palletized Boxes
15	25	500	72
50	15	90	72

## Germetex® FPU



Universal roofing seal — product made of flexible, open-cell polyurethane foam. On one side, it has adhesive surface protected by anti-adhesive paper or surface backed up with nonwoven fabric.

### PACKAGING: (Typical Dimensions)

Tape Width mm	Thickness mm	Wound on Spools (linear meter, lm)	Palletized Spools
70	6	700	12
100	6	500	12
55	6	1000	12

Tape Width mm	Thickness mm	Length (linear meter, lm)	In Packages
30	40	2	200

# ROOF

**GERMETEX®**  
sealing materials

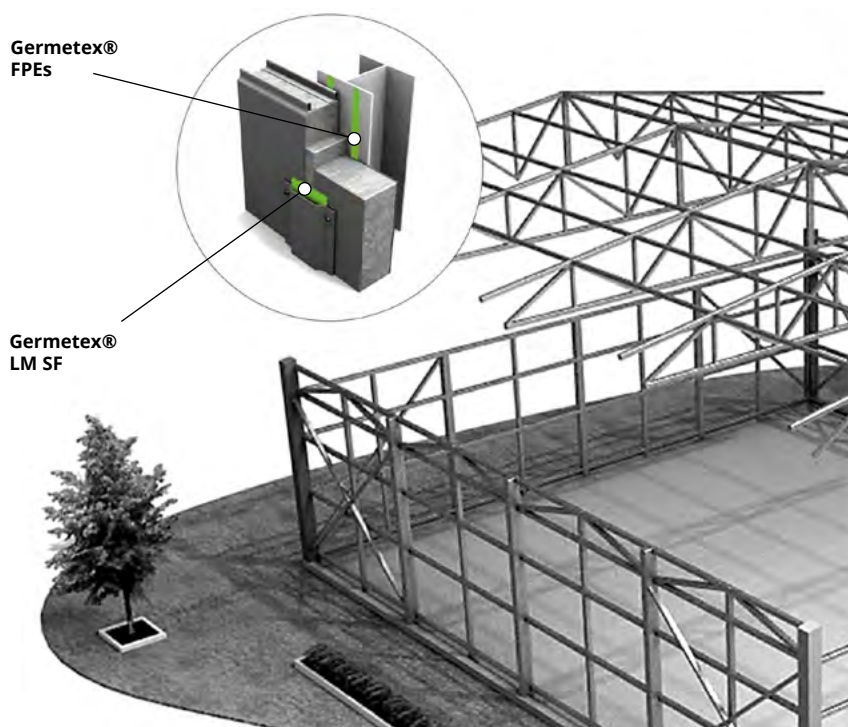

Installation of sealing elements is obligatory and crucial step when installing panels on load-bearing structures.

Which provides sealing and damping, as well as horizontal and vertical alignment along facades in cases of structural deviations.

## Germetex® PCST



PCST — pre-compressed, self-expanding, and self-adhesive elastic sealing tape based on polyurethane foam, impregnated with water-repellent dispersive acrylic.

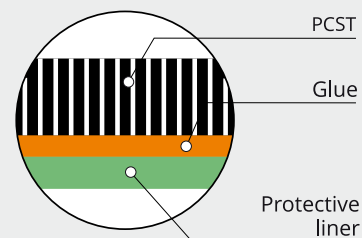

Arranged for vapor permeable waterproofing joints and connections.

**PACKAGING:** (Typical Dimensions)

Tape Width mm	Tape Length mm	Length per Roll (linear meter, lm)	Quantity per Box (linear meter, lm)	Palletized Boxes
20	40	4.5	58.5	80

## Germetex® FPEs

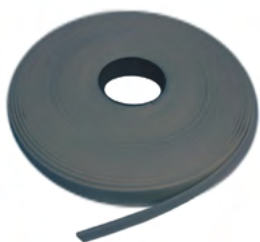

FPEs — self-adhesive tape based on foamed polyethylene (FPE), for solving problems of sealing panel joints in lock joints and for attaching to supporting structures.

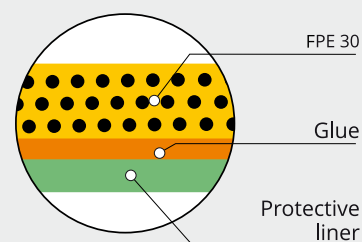

Sealing tape is designed to exclude contact of sandwich panels with reinforced concrete and metal structures.

**PACKAGING:** (Typical Dimensions)

Tape Width mm	Tape Thickness mm	Length per Roll (linear meter, lm)	Quantity per Box (linear meter, lm)	Palletized Boxes
30	3	25	375	18
9	2	10	200	36

# PRO 900

Innovative, bitumen-free, super lightweight, and self-adhesive roofing material  
**GERMETEX® PRO 900**

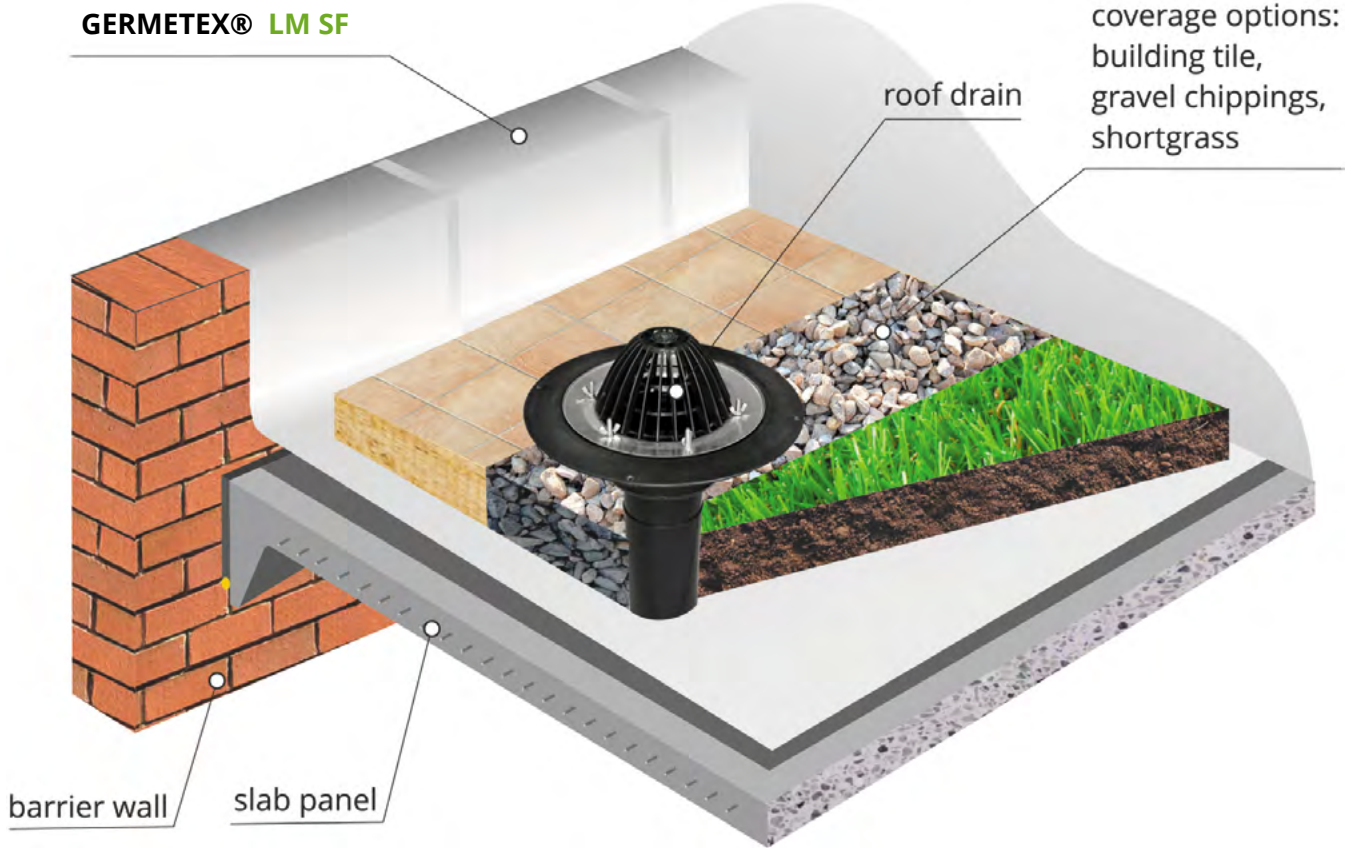

## WATER FUNNEL NEAR PARAPET SCUPPER

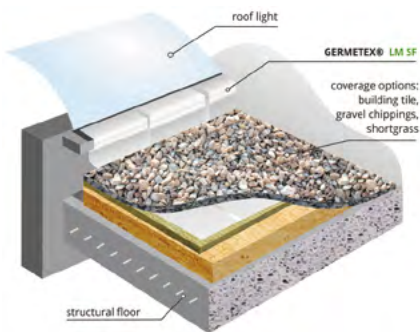

**CONNECTION DIAGRAM  
TO ROOF SKYLIGHT**

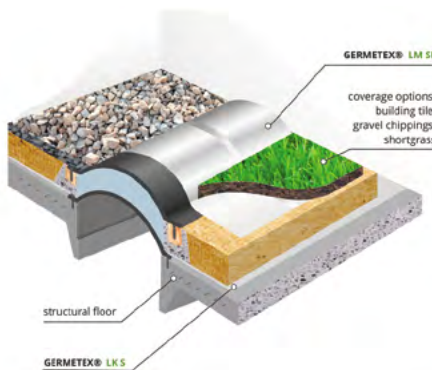

**EXPANSION JOINT  
WITH SEMICIRCULAR EXPANSION PIPE**

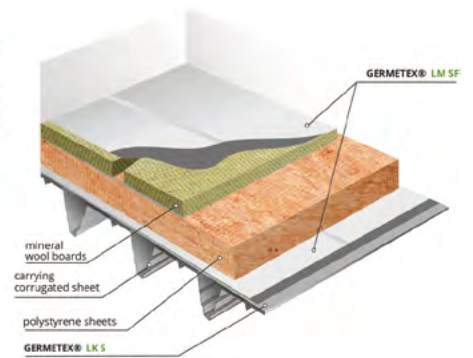

**STEAM BARRIER  
ALONG CORRUGATED BOARD**

1. GERMETEX PRO 900 Fire Safety – G1; RP-1; and C-1.  
To arrange fire diffusers around smoke removal hatches and skylights.
2. Saving 50% on connections to skylights, as no additional materials will be required.
3. Saving on metal structures (parapets, fire cuttings, etc.)
4. Saving on geotextile separating layers – no such layers will be required in places where GERMETEX® is installed.
5. GERMETEX® PRO 900 WARRANTY: 10 years.

# PRO 900

GERMETEX®  
sealing materials

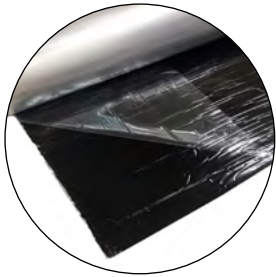

## GERMETEX® LM SF

Material is based on synthetic rubber, glass fiber reinforced, with protective layer of aluminum foil on outside surface.

### SPECIFICATIONS:

Bond strength with concrete – not less than 5.0 N/cm.  
Bond strength with metal – at least 5.0 N/cm.  
Resistance to vapor permeation – not less than 2.0 m<sup>2</sup>hPa/mg.  
Flexibility on bar – 40 °C. Heat resistance 85 °C.  
Water tightness, 600 Pa. Flammability Class G1.  
Flammability Rating B1. Work Surface Class – 1



### PACKAGING: (Typical Dimensions)

Roll Width mm	Thickness mm	Length per Roll (linear meter, lm)	Palletized pcs
940	1	20	36
940	1	10	21

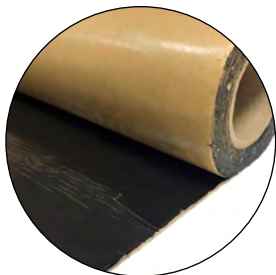

## GERMETEX® LK S

Material is based on synthetic rubber, reinforced with fiberglass and has adhesive surfaces on both sides.

- no dismantling of old coating required;
- time of installation works reduced;
- no special trained personnel required;
- applied without use of fire;
- not subject to decay;
- withstands temperature from -40 C° to +85 C°, maintaining all sealing properties;
- used at low temperatures without additional heating.

### SPECIFICATIONS:

Bond strength with concrete – not less than 5.0 N/cm.  
Bond strength with metal – at least 5.0 N/cm.  
Resistance to vapor permeation – not less than 2.0 m<sup>2</sup>hPa/mg.  
Flexibility on bar -40 °C. Heat resistance 85 °C.  
Water resistance, 600 Pa.

### PACKAGING: (Typical Dimensions)

Roll Width mm	Thickness mm	Length per Roll (linear meter, lm)	Palletized pcs
900	1	20	24
900	1	10	40

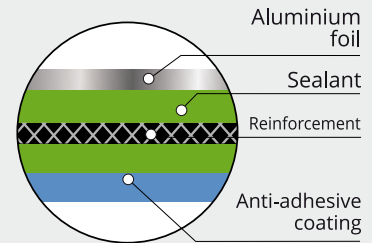

Installation and repair of soft roofs, flat roofs with traditional and inverted roofs on reinforced concrete slabs, and on old coating, including polyurea.

Installation and repair of pitched roofs with metal folded, slate, corrugated roofs, concrete slabs, brickwork, OSB, wood, etc.

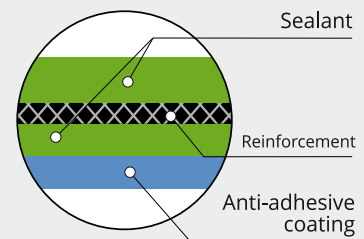

Installation and repair of soft roofs and flat roofs - used as hydro-vapor barrier of roof underlayer.

Installation of heat-insulating plates (expanded polystyrene) to the base.

# ROADWAYS

**GERMETEX®** sealing materials – **Series of Roadways materials** —  
for sealing cold technological joints of asphalt concrete pavements, as a necessary element to  
increase the turnaround time.

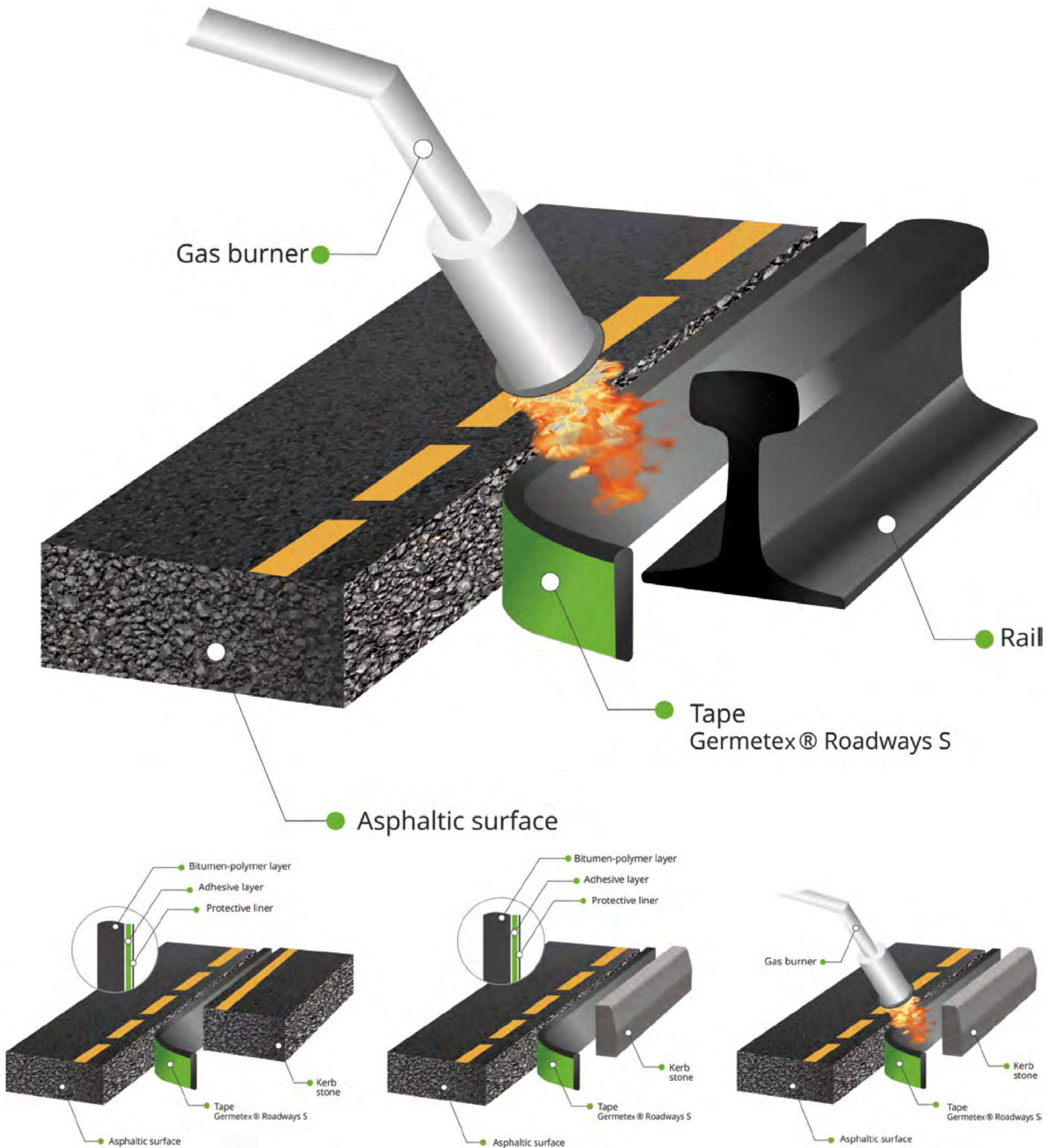

TYPICAL JOINTS

# ROADWAYS

**GERMETEX®**  
sealing materials



**New!**

## VALUE OF THE OFFER:

**GERMETEX®** products meet Customer's specification: physicochemical, technological, and overall parameters.



### GERMETEX® Roadways TP

Thermo-fusible bitumen-polymer tape to seal joints and junctions in construction and reconstruction of asphalt concrete roads.

#### SPECIFICATIONS:

Heat resistance (Ring and Ball Method) °C: 90.  
Tape width: from 50 mm to 200 mm.  
Thickness: 5 mm to 10 mm. Winding: on cores, into rolls.

#### PACKAGING: (Typical Dimensions)

Tape Width mm	Tape Thickness mm	Length per Roll (linear meter, lm)	Quantity per Box (linear meter, lm)	Palletized Boxes
50	5	10	30	24

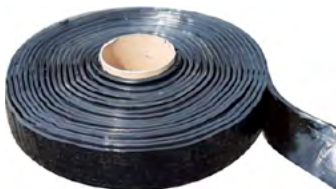

### GERMETEX® Roadways S

Self-adhesive bitumen-polymer tape to seal joints and junctions during construction and reconstruction of asphalt-concrete roads.

#### SPECIFICATIONS:

Heat resistance (Ring and Ball Method) °C: 90  
Rubber glue: thickness 50 grams/m<sup>2</sup>.  
Tape width: 50 mm to 200 mm.  
Thickness: 50 mm to 200 mm.  
Winding: on cores into rolls.  
Adhesive is coated with protective PET liner with silicone.

#### PACKAGING: (Typical Dimensions)

Tape Width mm	Tape Thickness mm	Length per Roll (linear meter, lm)	Quantity per Box (linear meter, lm)	Palletized Boxes
50	5	10	30	24

Fast and economical application. Excellent elastic and adhesive specifications.

LINK TO YANDEX DISC:  
<https://yadi.sk/i/RW6aDDIBm6v39A>

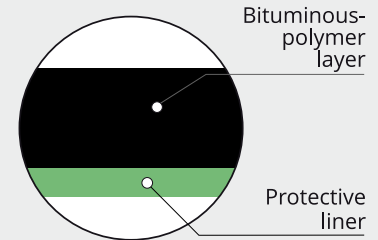

One of advantages of using high-polymer joint tapes is their ability to act as shock-absorbing cushions dampening vibrations at asphalt-concrete - rail junctions.

This prevents the asphalt from being destroyed by vibration, but the performance of the belt becomes fully apparent only at a thickness of 10 mm.

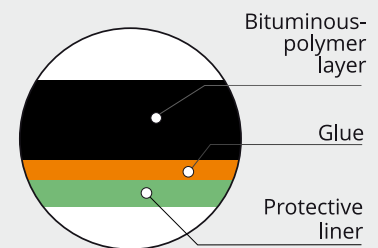

Does not require special equipment (gas burner); flow control - during application.



**GERMETEX®**  
sealing materials

# ACOUSTICS

**GERMETEX® ACOUSTICS** range of materials – soundproof membrane for walls, partitions, and floors and ceilings. Installation between layers of sheet building material (OSB, laminate, plywood, and drywall). Provides improvement in  $R_w$  EN 140-3 performance.

VALUE OF OFFER: adaptation of **GERMETEX®** products to Customer's specifications: physical and chemical parameters, technological, and overall dimensions.

Application of **GERMETEX® ACOUSTICS** materials:

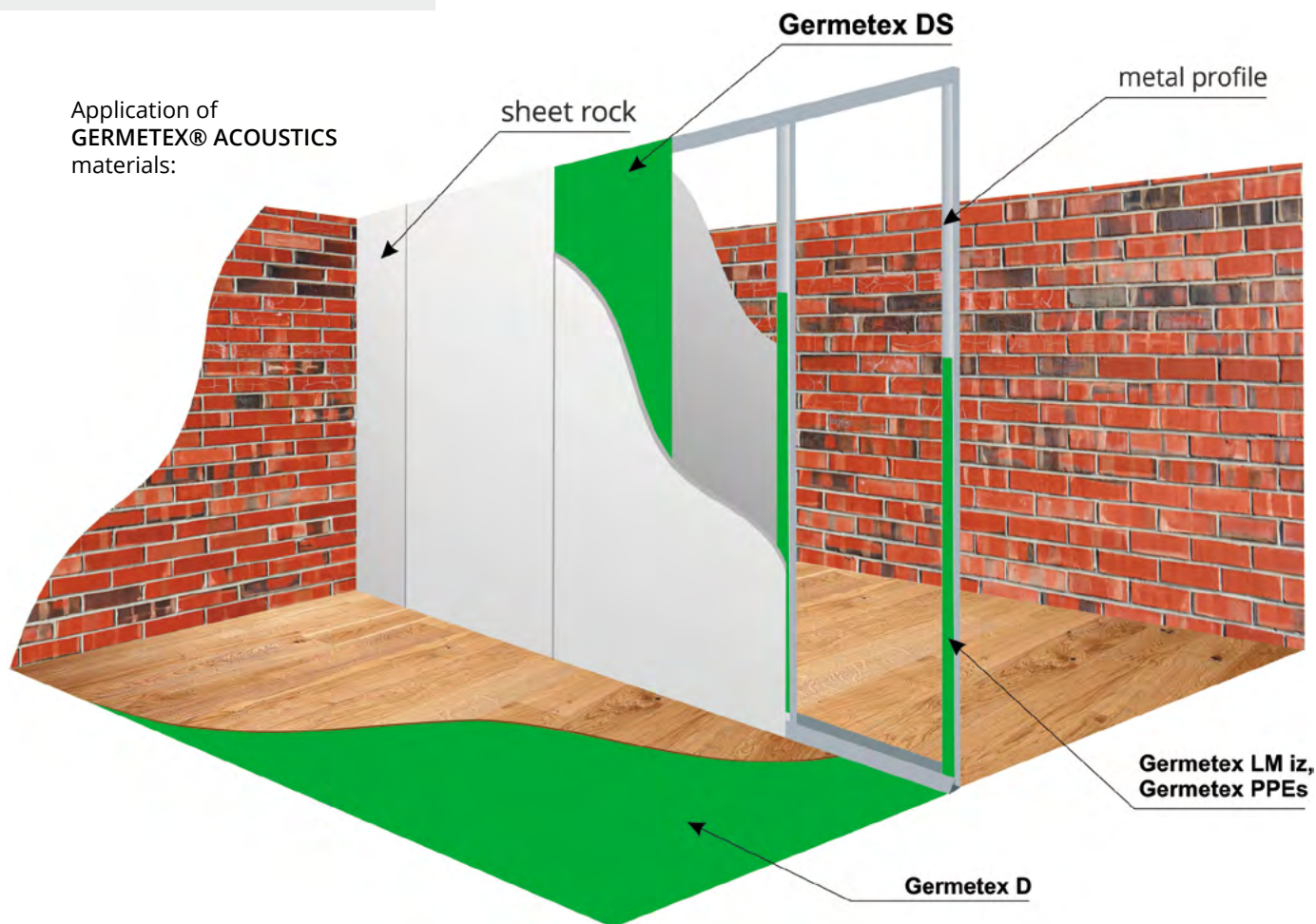

## Germetex® D

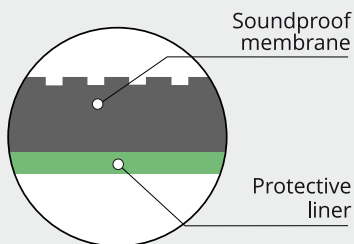

Used in conjunction with traditional sound-absorbing materials (Rockwool, Paroc, Isover, URSA, etc.).



## Germetex® D

Highly filled (heavy) soundproof membrane with high degree of elasticity at thicknesses of 2 mm to 5 mm. Moisture-resistant and heat-resistant (up to 100 °C) membrane. Does not contain lead and asbestos. Optional delivery in sheets and rolls.

### SPECIFICATIONS:

Density ( $g/cm^3$ ) – 200. Tensile strength (MPa) – 0.87.  
Elongation (%) – 250. Shore hardness (Shore A) –38.

### PACKAGING: (Typical Dimensions)

Sheet Dimensions mm	Sheet Thickness mm	Quantity per Box pcs	Palletized Boxes
600x1200	4	5	20
600x1200	2	10	20

# ACOUSTICS



## Germetex® DS

Highly filled (heavy) soundproof membrane with self-adhesive layer. Reduces consumable costs and simplifies installation. Also it is highly elastic at thicknesses from 2 mm to 5 mm and is safe. Free of lead and asbestos.

### SPECIFICATIONS:

Density (g/cm<sup>3</sup>) — 200. Tensile strength (MPa) — 0.87.  
Elongation (%) — 250. Shore hardness (Shore A) — 38.

### PACKAGING: (Typical Dimensions)

Sheet Dimensions mm	Sheet Thickness mm	Quantity per Box pcs	Palletized Boxes
600x1200	4	5	20
600x1200	2	10	20

## Germetex® AC

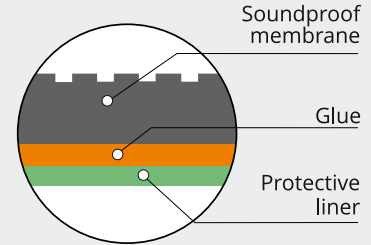

To improve performance, installation in several layers is possible, including through separators (Rockwool, Paroc, Isover, URSA, etc.)

## Germetex® FPEs, LMiz



**FPEs** — designed for noise protection of metal frames, partitions, facings and ceilings. It is glued to guide profiles of ceilings and floors, as well as to rack profiles of wall claddings.



**LMiz** — improves insulating properties of plasterboard partitions at junctions to floors, walls, and ceilings.

Sealing, noise-absorbing, and anti-condensation self-adhesive butyl rubber tape, backed up with foamed polyethylene (physically cross-linked).

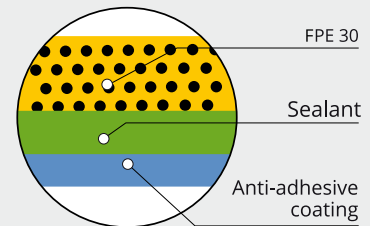
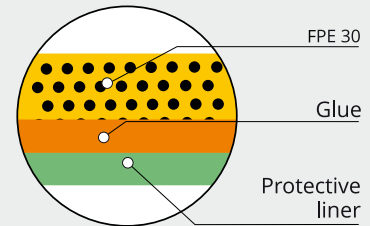

### SPECIFICATIONS:

Minimum installation temperature, °C: - 15.  
Operating temperature: from - 60 °C to + 90 °C.  
Width of tapes: from 10 mm to 900 mm. Seal thickness: from 2 mm to 10 mm.  
Sealant thickness: 0.6 mm to 3 mm.  
Length of tapes, m: depending on thickness of insulation.

### PACKAGING: (Typical Dimensions)

#### FPES

Tape Width mm	Length per Roll m	Quantity per Coil (linear meter, lm)	Palletized Coils
30	25	375	18
100	25	125	18

#### LMiz

Tape Width mm	Length per Roll m	Quantity per Coil (linear meter, lm)	Palletized Coils
50x2x15	12	36	60



**GERMETEX®**  
sealing materials

# AUTO

**GERMETEX®** Auto series of materials are used in auto, mechanical engineering, shipbuilding, elevator construction and in other equipment where noise and vibration are required to be reduced.

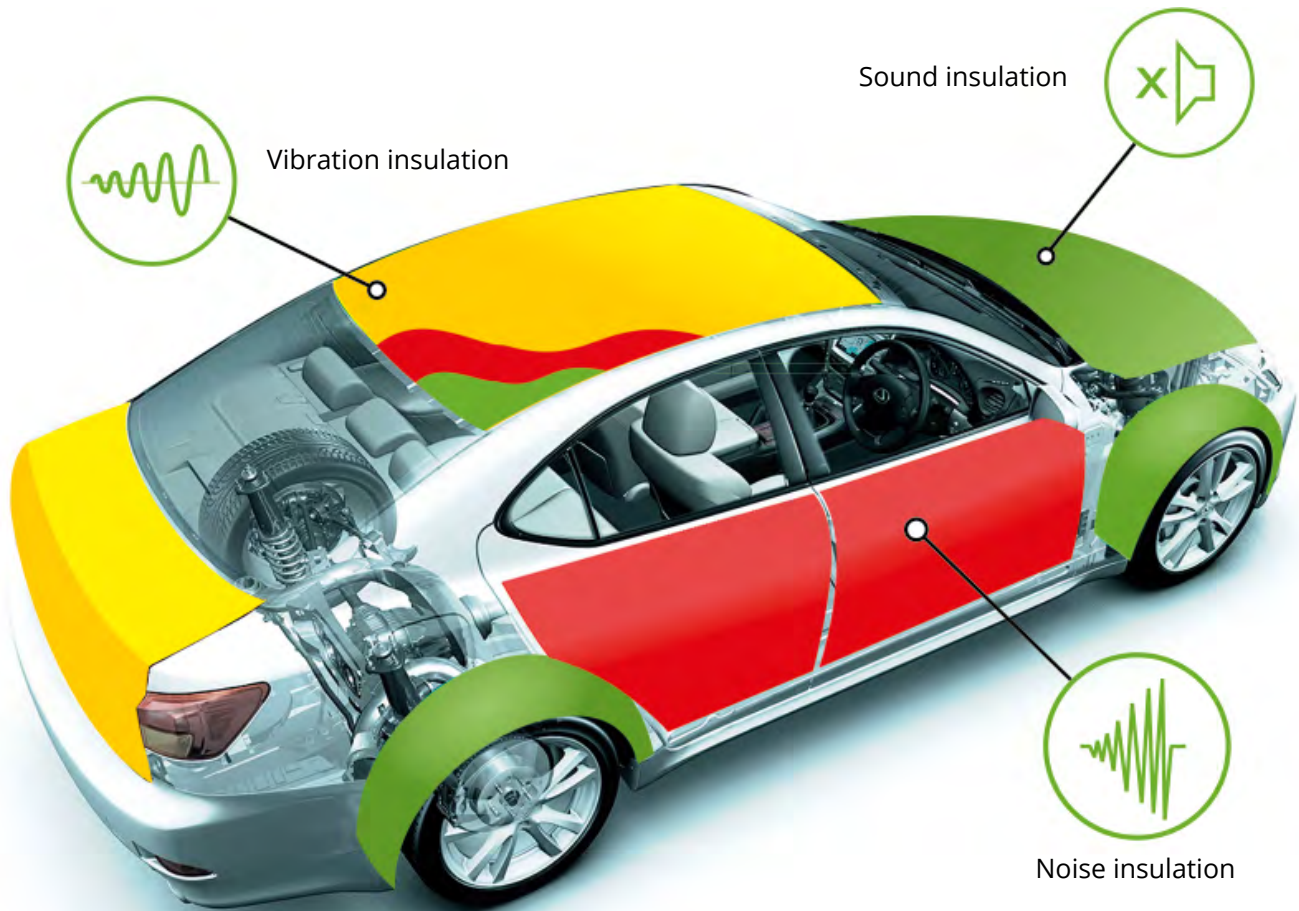

## **EFFECTIVE REDUCTION OF NOISE AND VIBRATION**

in such differing environment is achieved by combined use of vibration-insulating and sound-insulating **GERMETEX®** materials.

## **GERMETEX® AUTO MATERIALS INSTALLATION PROCEDURE**

First layer is applied to vibration isolation materials onto pre-conditioned surfaces (without dirt and dust).

Sound absorbing material is applied as the second layer after the vibration isolation layer!

## SOUND INSULATION

### GERMETEX® Wave (FPU)



Self-adhesive acoustic material with adhesive layer possesses high sound absorption properties. Easily mounted on vertical and curved surfaces, used as second layer after vibration isolation.

#### PACKAGING: (Typical Dimensions)

Width of Sheet mm	Thickness of Sheet, mm	Length of Sheet mm	Quantity per Box pcs	Palletized Boxes
750	6	1000	10	10
750	10	1000	10	10

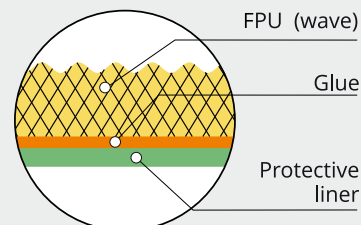

Applied to ceilings, door cards, plastic sheathings, and car pillars.

### GERMETEX® Bitumen (FPU)



Self-adhesive polyurethane foam with adhesive layer and good impregnation with bitumen emulsion. It possesses soundproofing properties, is used as anti-creak, sealing material, easily applied to vertical and curved surfaces.

#### PACKAGING: (Typical Dimensions)

Width of Sheet mm	Thickness of Sheet, mm	Length of Sheet mm	Quantity per Box pcs	Palletized Boxes
750	5	1000	20	10
750	10	1000	10	10

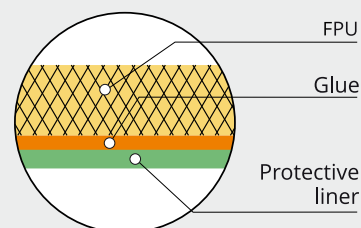

It is applied to car door cards, interior plastic panels at plastic joints.

## NOISE INSULATION

### GERMETEX® FPE, FPE M

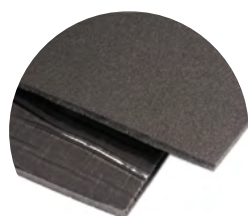

Self-adhesive heat-noise-insulating material with adhesive layer possesses high heat and sound insulating properties, can be easily mounted on straight surfaces, used as second layer after vibration isolation.

FPE M — additionally protected by a metallized film. Sound absorption coefficient (at 1600 Hz frequency) using acoustic analyzer type «Brüel & Kjaer»: 0.31-0.34.

#### PACKAGING: (Typical Dimensions)

Width of Sheet mm	Thickness of Sheet, mm	Length of Sheet mm	Quantity per Box pcs	Palletized Boxes
750	4	1000	30	10
750	8	1000	20	10

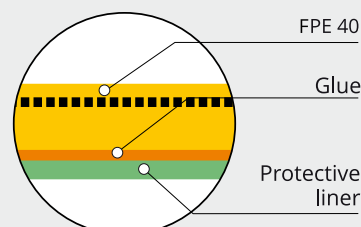

FPE

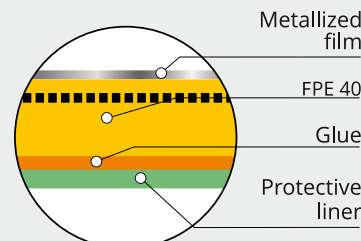

FPE M

Applied as second layer on doors, floors, ceilings, and car trunks.



**GERMETEX®**  
sealing materials

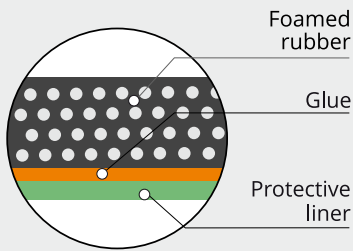

Applied as second layer on doors, floors, ceilings, and car trunks.

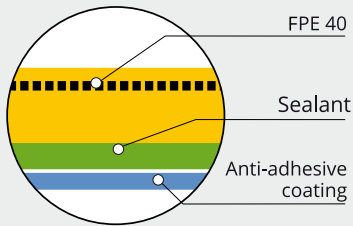

Installation - in one layer or second layer on doors, floors, ceilings, fenders, and car trunks.

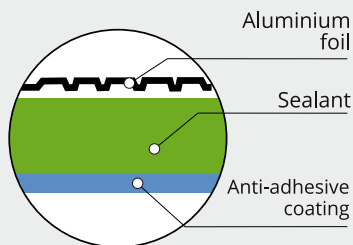

As first layer on car body elements (doors, ceilings, floors, trunks, hoods, etc.)

# AUTO

## NOISE INSULATION

### GERMETEX® S-Flex

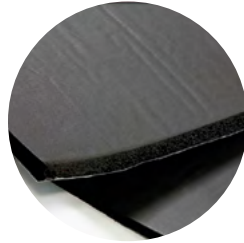

One of most effective heat and noise insulators based on foamed rubber, self-adhesive material in sheets.

#### SPECIFICATIONS:

Flammability group - G1 (GOST 30244-94).

Thermal conductivity coefficient, W/(m.k.): 0.036

#### PACKAGING: (Typical Dimensions)

Width of Sheet mm	Thickness of Sheet, mm	Length of Sheet mm	Quantity per Box pcs	Palletized Boxes
750	6	1000	20	10
750	10	1000	10	10

### GERMETEX® Diz

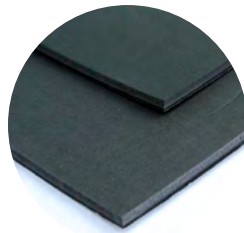

Diz mastic product is used as sound and heat insulating material. It is applied as second layer, on top of vibration isolation layer — this allows to quickly warm up interior of cabin in cold weather and more efficiently cool it in heat periods.

#### SPECIFICATIONS:

Thermal conductivity coefficient, W/(m.k.): 0.036

Adhesion to metal (kg/cm): 0.5

#### PACKAGING: (Typical Dimensions)

Width of Sheet mm	Thickness of Sheet, mm	Length of Sheet mm	Quantity per Box pcs	Palletized Boxes
450	4	650	10	30

## VIBRATION INSULATION

### GERMETEX® DF

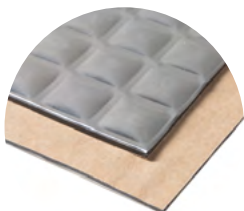

Vibration-absorbing, self-adhesive material based on 60-, 100-micron foils. It is used as first layer for vibration isolation of cars. Easy to mount on complex relief surfaces and does not require heating.

#### PACKAGING: (Typical Dimensions)

Width of Sheet mm	Thickness of Sheet, mm	Length of Sheet mm	Quantity per Box pcs	Palletized Boxes
500	1.5	650	25	30
500	2	650	20	30
500	3	650	15	30

## SUPPLEMENTARY GOODS

### GERMETEX® LM nw

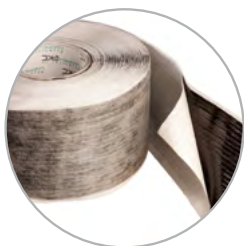

Sealing self-adhesive butyl rubber LM nw tape, coated on one side with anti-adhesive coating (paper) on reverse side with nonwoven fabric. Optional back up: metallized film, isolon (FPE), foil, and PVC.

**PACKAGING:** (Typical Dimensions)

Width of per Roll mm	Thickness of per Roll, mm	Length of per Roll (linear meter, lm)	Quantity per Box pcs	Palletized Boxes
200	2	12	24	45

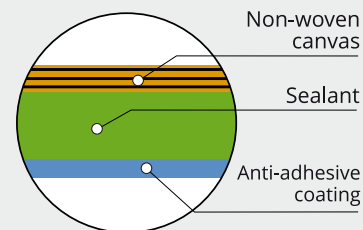

Applied to panels and plastic elements of cars

### GERMETEX® Zh



Packing strip for headlights and seams. This sealant is used to install headlights with no rubber seals.

That provides excellent moisture resistance and anti-corrosion properties.

**PACKAGING:** (Typical Dimensions)

Packing Strip Dia. mm	Length per Roll (linear meter, lm)	Quantity per Box (linear meter, lm)	Palletized Boxes
5	10	50	40
8	5	100	40

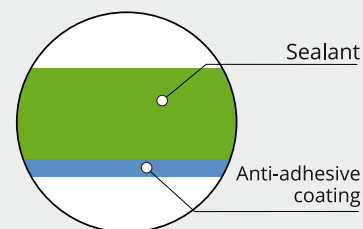

Applied to panels and plastic elements of cars.

### GERMETEX® Carpet

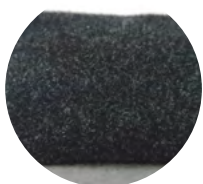

Decorative acoustic material with adhesive coating to decorate. To decorate acoustic shelves and subwoofers.

**PACKAGING:** (Typical Dimensions)

Width of Roll mm	Length per Roll (linear meter, lm)	Palletized pcs
1450	10	20

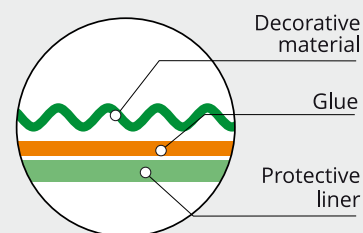

**GERMETEX® Carpet, Madeline**

### GERMETEX® Madeline

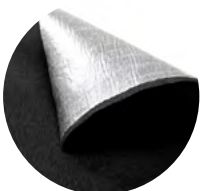

Fabric material, anti-creak, used to eliminate creaking (plastic with plastic, plastic with metal) In the gaps between the parts of passenger compartment and the car body.

**PACKAGING:** (Typical Dimensions)

Width of Tape mm	Length of Sheet mm	In Boxes pcs	Palletized Boxes
750	1000	20	40



Professional tool.  
Roller for stitching.  
Roller size: 20mm, 30mm



**GERMETEX®**  
sealing materials

SEQUENCE OF WORKS:

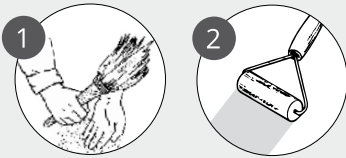

Clear surface

Prime coat surface

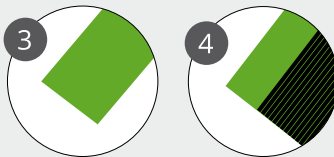

Apply evenly  
**GERMETEX®**  
LM X, T

Apply adhesive

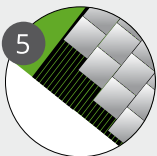

Lay tiles

**VALUE OF OFFER:**

Self-adhesive technology, turnkey solution to control quantity and quality of waterproofing.

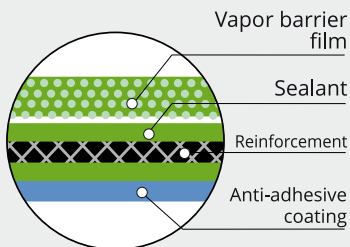

Before applying **GERMETEX® LM X** waterproofing, base preparation is required (dust removal and priming)

# WATERPROOFING

## GERMETEX® LM T, LM X WATERPROOFING



**GERMETEX®**  
LM T

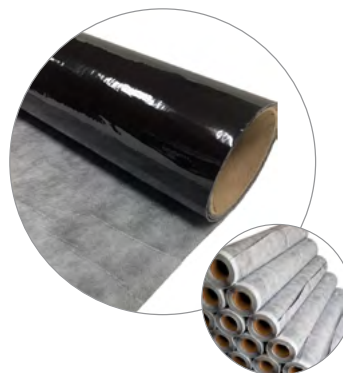

### GERMETEX® LM X WATERPROOFING

Used for unheated floors. Installation is carried out without heating, on dry preconditioned surfaces. For waterproofing vertical and horizontal surfaces, for outdoor and indoor use.

**PACKAGING:** (Typical Dimensions)

Tape Width/Thickness, mm	Length per Roll (linear meter, lm)	Area per Roll m <sup>2</sup>	Palletized kg
450/1	10	4.5	72

# WATERPROOFING

**GERMETEX®**  
sealing materials



## GERMETEX® LM T WATERPROOFING

Used in conjunction with underfloor heating systems (electric mats, water underfloor heating, etc.).

### SPECIFICATIONS:

- Adhesion to concrete (kg/cm) — 0.5.
- Adhesion to metal (kg/cm) — 0.5.
- Vapor permeability resistance mg/(m<sup>2</sup>.h.Pa) — 0.002.
- Winding on core into rolls.
- Heat resistance — 160 °C.
- Any type of primer is suitable, if applied onto dry surface.



### PACKAGING: (Typical Dimensions)

Tape Width/Thickness, mm	Length per Roll (linear meter, lm)	Area per Roll m <sup>2</sup>	Palletized kg
450/1	10	4.5	72

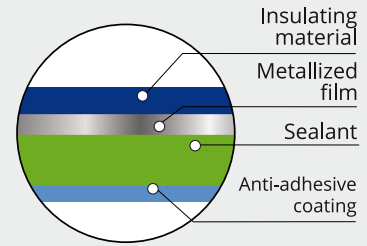

When installed in combination with underfloor heating, installation technology remains same, underfloor heating system is laid over the waterproofing.

Before applying **GERMETEX® LM T** waterproofing, preconditioning of base (dedusting and priming) is required.

# RUBBER COMPOUND



## GERMETEX® RUBBER COMPOUND

**GERMETEX®** rubber compound — non-curing, sealing compound looking as paste, sealant or mastic. Consists of compositions of natural and synthetic rubbers, filler, plasticizer, and functional additives.

### SPECIFICATIONS:

- Penetration: from 2 mm to 13 mm.
- Water absorption: from 0 to 0.5%.
- Rubber-to-metal bond strength using peel test: from 1 to 15 N/cm.
- Rubber-to-concrete bond strength using peel test: from 1 to 15 N/cm.
- Thermal resistance (Ring and Ball Method): from 70 °C to 300 °C.

**APPEARANCE:** homogeneous mass, white, gray, black or beige (colour options on request).

### PACKAGING: (Typical Dimensions)

Bricks kg	Quantity per Bag pcs	Palletized kg
2	40	600

### APPLICATION:

To manufacture products of shape-formed as parts, tapes, rolls, and packing strips in civil and industrial construction, in automotive industry, in household appliances industry and other areas of national economy.



**GERMETEX®**  
sealing materials

New!

**GERMETEX®** heat-shrinkable radiation-cross-linked clutch (coupling) insulates joints, different diameters reducers, cold and heat-insulated steel and polymer pipes.

**GERMETEX® LK** tape provides waterproofing of joints. Clutch (coupling) after shrinkage provides mechanical and structural strength of connection. Kits include: heat-shrinkable clutch (coupling), sealing tape. Also, complete kits are available to fill internal space of PPU in case of heat-insulated FPU.

The pipe size range is 1450-32 mm. Clutch (coupling) is made of polyethylene by extrusion and subsequent longitudinal stretching in order to create the effect of heat shrinkage, that is, to restore original geometric dimensions when heated.

#### VALUE OF OFFER:

Convenient, universal solution to connect and seal pipes of different technological parameters.

## CLUTCH (COUPLING)

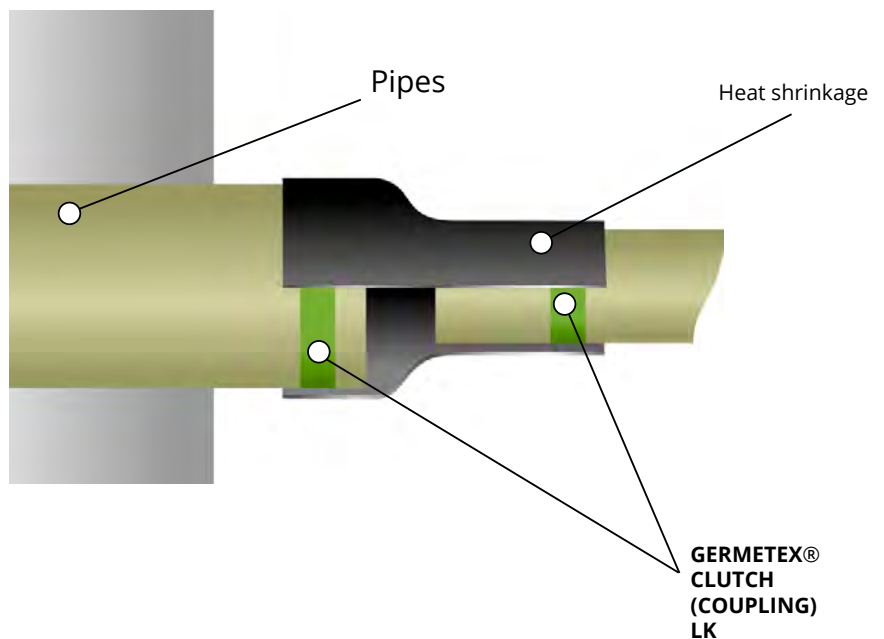

### GERMETEX® CLUTCH (COUPLING)

Heat-shrinkable radiation-cross-linked coupling.

#### SPECIFICATIONS:

Thickness of radiation-cross-linked coupling is 0.8 mm.

Thickness of sealing strip is 1 mm.

Adhesive strip widths on request, from 3 mm to 900 mm.

#### SEALANT CHARACTERISTICS:

























Softening Point (Ring and Ball Method)  
ASTM E-28, typical indicator 155 °C

Low Temperature Flexibility ASTM (D - 2671),  
typical indicator - 40 °C

Peel Strength ISO (21809-3), typical indicator  
(at 23 °C) 8 N/cm

Legend of **GERMETEX®** of product components:

---

 Sealant	 Aluminium foil
 Back-up Basis (primer)	 FPE 40
 Glue	 Bituminous-polymer layer
 Anti-adhesive coating	 Non-woven canvas
 Breathable membrane	 FPE 30
 Sealing cork material	 Metallized film
 Vapor barrier film	 FPU (wave)
 Insulating material	 FPU
 Reinforcement	 Protective liner
 Soundproof membrane	 PCST
 Al Foil, embossed	 Decorative material
 Foamed rubber	 FPU ROOF



Germetex Production Association

**5-th Montersky Alley, Building 60, Syzran, 446022, Samara Region, Russian Federation**

Phone number: +7-800-550-61-01 (Sales department), +7-927-781-23-06 (WhatsApp)

E-mail: [info@germeteks.su](mailto:info@germeteks.su)

Working hours: Monday-Friday – 08:30-17:00, (lunch break: 12:30-13:00), Saturday-Sunday — off days